

FR 692

Interruptor de seguridad actuados separado serie ligera

Características Generales

Carcaza:

Plastica, una entrada de PG 13,5

Bloque de contacto:

1NA+1NC (B6)

Apertura:

Positiva

Grado de protección:

IP67 de acuerdo con EN60529

Temperatura ambiente:

-25°C a 80°C

Frecuencia de operación:

3600 ciclos / hora

Vida mecánica:

20 millones de operaciones

Corriente térmica (I_{th}):

10 Amp

Voltaje máximo de operación:

500 VCA, 600 VCD

Corriente de utilización C.A.:

250V (6 Amp) 400V (4 Amp) 500V (1 Amp)

Corriente de utilización C.D.:

24V (4 Amp) 125V (1.1 Amp) 250V (0.4 Amp)

Diagrama

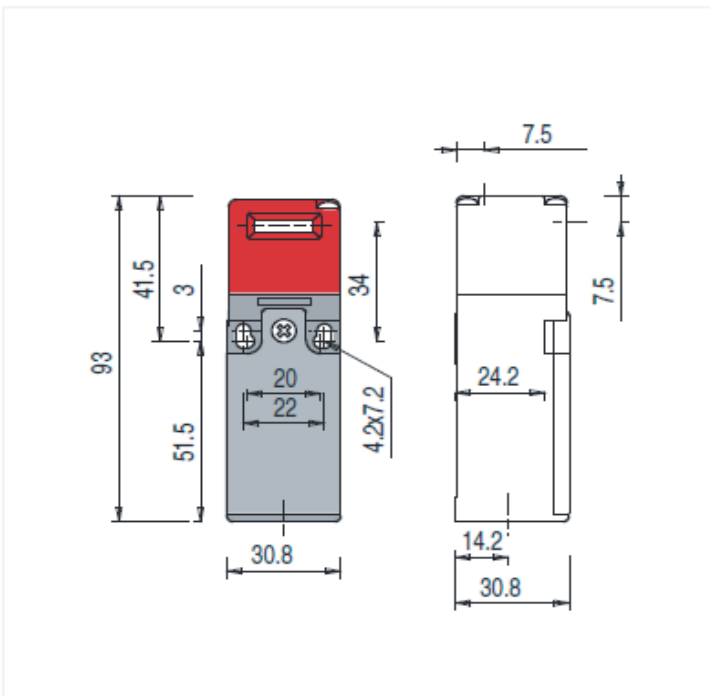

ACCESORIOS

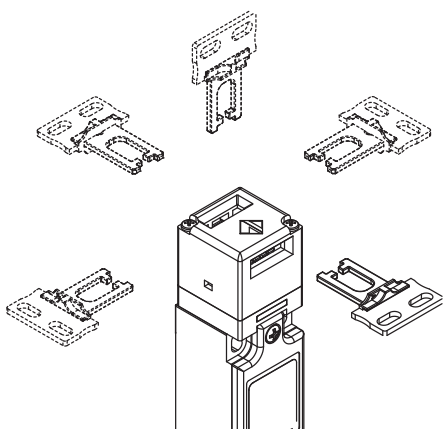

CABEZA ROTATORIA EN PASOS DE 90°



VF KEYD



VF KEYD1



VF KEYD2



VF KEYD3



VF KEYD5

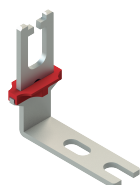

VF KEYD6

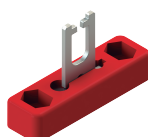

VF KEYD7



VF KEYD8



VF KEYD10



VF KEYD11

Marcas de Calidad

