

FP 2078

Interruptor de seguridad de cuerda con reset para paro simple serie pesada.

Características Generales

Carcaza:

Plástica , una entrada de PG 13,5

Bloque de contacto:

1NA+2NC(B20)

Apertura:

Positiva

Grado de protección:

IP67 de acuerdo con EN60529

Temperatura ambiente:

-25°C a 80°C

Frecuencia de operación:

3600 ciclos / hora

Vida mecánica:

20 millones de operaciones

Corriente térmica (Ith):

10 Amp

Voltaje máximo de operación:

500 VCA, 600 VCD

Corriente de utilización C.A:

250V (6 Amp) 400V (4 Amp) 500V (1 Amp)

Corriente de utilización C.D:

24V (6 Amp) 125V (1.1 Amp) 250V (0.4 Amp)

Diagrama

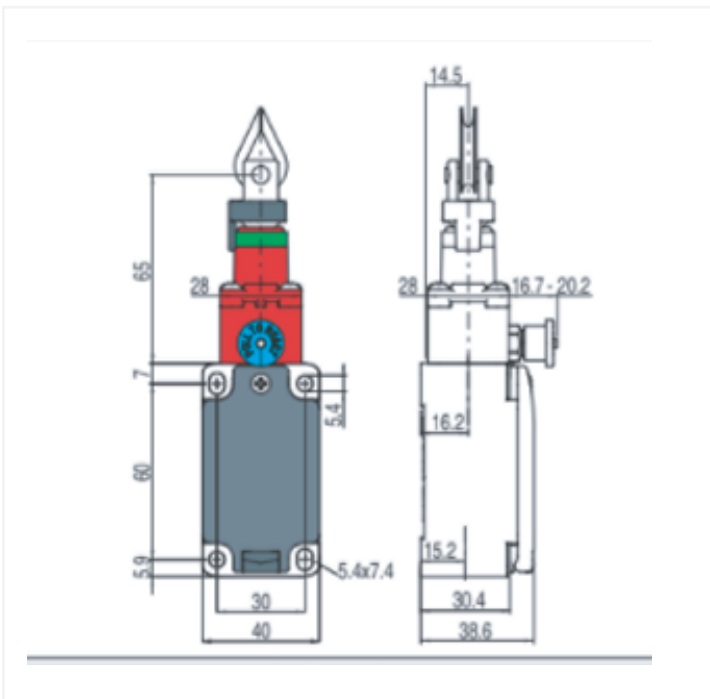

ACCESORIOS

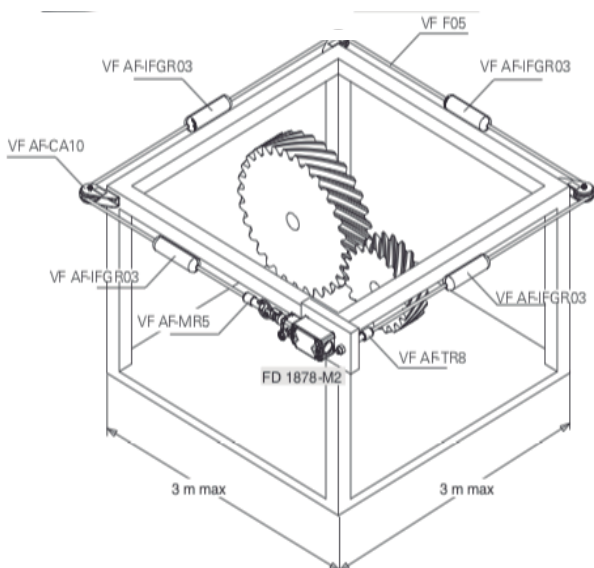

VF AF-TR5



VF AF-MR5



VF AF-TR8



VF AF-CA5



VF AF-CA10



VF AF-ME78



VF AF-ME80

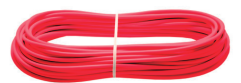

VF F0510

Marcas de Calidad

